



BELGIAN BUILDING RESEARCH INSTITUTE

INSTITUTION RECOGNIZED BY APPLICATION OF THE DECREE-LAW OF THE 30th OF JANUARY 1947



NBN-EN-ISO/IEC 17025

- Test centre : B-1342 Limelette, Avenue P. Holoffe 21
- Offices : B-1932 Sint-Stevens-Woluwe, Lozenberg 7
- Head office : B-1000 Brussels, Rue du Lombard 42

Tel : (32) 2 655 77 11
Tel : (32) 2 716 42 11
Tel : (32) 2 502 66 90

Fax : (32) 2 653 07 29
Fax : (32) 2 725 32 12
Fax : (32) 2 502 81 80

VAT n°: BE 407.695.057

www.bbri.be

Page 1 / 6

LABORATORY OF ACOUSTICS

TESTREPORT Nr. AC 4305

Requested by: GLAVERBEL s.a.
Parc Industriel, zone C
B-7180 SENEFFE
Belgium

Contacts:

Company:
F. Bonnefoy

BBRI - WTCB - CSTC - WTB
M. Van Damme

Test carried out: Measurement of the sound reduction index R of a building element

Product tested: Glazing Pyrobel 21 EG

References

EN ISO 140-3: 1995 Acoustics – Measurement of sound insulation in buildings and of building elements
– Part 3: Laboratory measurements of airborne sound insulation of building elements (ISO 140-3:1995)
EN ISO 717-1: 1996 Acoustics-Rating of sound insulation in buildings and of building elements
– Part 1: Airborne sound insulation (ISO 717-1:1996)

Date and reference of the order:	13-03-07	Nr. DE 631 x A506
Receipt of the test element:	28-03-07	Nr. Test element: 2007-13-007/1
Date of the test:	13-04-07	
Drafting date of the report:	23-04-07	

This report contains (all annexes included) 6 pages. It may only be reproduced in its entirety. Each page of the original report has been stamped (in red) by the laboratory and initialised by the head of laboratory. The results and findings are only valid for the tested samples.

- No sample
 Sample(s) submitted to a destructive test
 Sample(s) to be removed from our laboratories 10 calendar days after sending of the report, unless a written request is received by the demander of the test

Responsible engineer in charge of the test,

Chief technician,

The head of the laboratory,

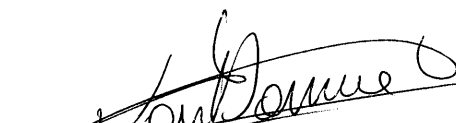
ing. M. Van Damme

P. Huart

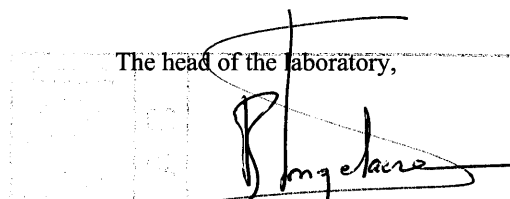
ir. B. Ingelaere

Technical assistant : /

**MEASUREMENT PRECISION, MEASUREMENT APPARATUS AND TEST CELLS****1. THE PRECISION OF THE MEASUREMENTS**

The precision of the measurement results are : +/- 2dB from 100 Hz up to 315 Hz and +/- 1dB higher than 315 Hz.

2. TEST EQUIPMENT**Signal**

- Brüel & Kjaer -1405: A noise generator
- Crown MacroTech 2400: An amplifier
- Nexo PS 15: A preamplifier
- Electro-Voice 2710: An equalizer
- 01dB-DO12: Loudspeakers

Microphones

- Brüel & Kjaer - 4165: One microphone on the emission side, one on the reception side
- Brüel & Kjaer - 2639: Two preamplifiers for microphones
- Brüel & Kjaer - 4220: Calibration source
- Brüel & Kjaer - 3923: Two rotating microphone booms; Number of rotations in each cell: 5; Number of inclinations: 5.
- Brüel & Kjaer - 2804: Two current supplies for microphones

Signal analysis

- Brüel & Kjaer - 2133: A real time analyser
- Computer + software
- Averaging time per measurement: 5 x 64 s
- Number of reverberation time measurements: 5

Test cells

- Volume of the emission room: 50.5 m³
- Volume of the reception room: 49.2 m³
- Total surface of the separating wall: 10.7 m²
- Surface of the test opening: 1.82 m²
- Composition of the separating wall:
2 x 20 cm hollow concrete blocs filled with stabilised sand, gap of 6 cm filled with rock wool.
- Total depth of the niche: 46 cm (subdivided in 1/3d emission side / 2/3d reception side)
- Diffusors and absorption material are present.

Mounting of the window

The glass pane (1.23 m x 1.48 m) is installed into the test opening so that the niches on both sides of the glass pane have different depths with a ratio of 2:1. A gap of about 10 mm remains between the glass and the reveal of the test opening. This gap is filled with putty as specified in EN ISO 140-3:1995 annex A (PERENNATOR TX 2001 S). To fix the test specimen, two wooden beads (25 mm x 25 mm) are used (see figure). The space (about 5 mm) between the pane and the locking edge is filled with the same putty. The beads cover between 12 mm and 15 mm of the glass. For more details, see EN ISO 140-3:1995.

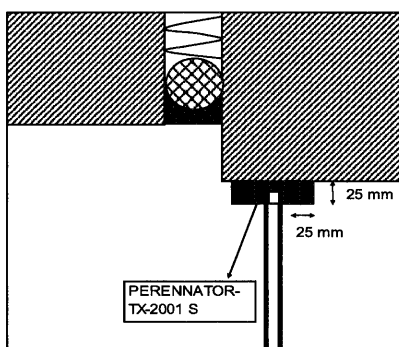
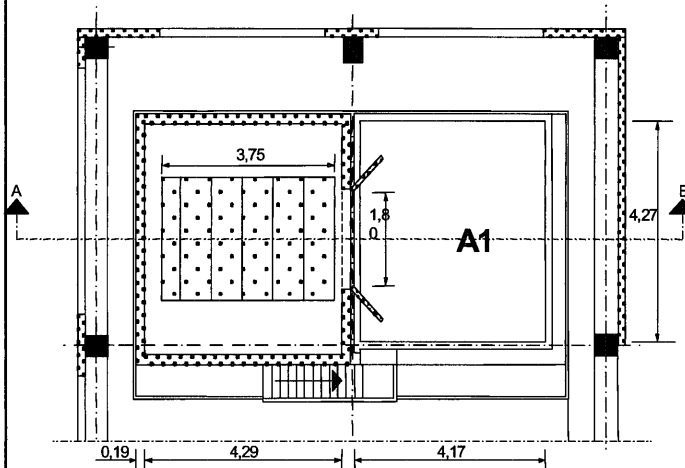
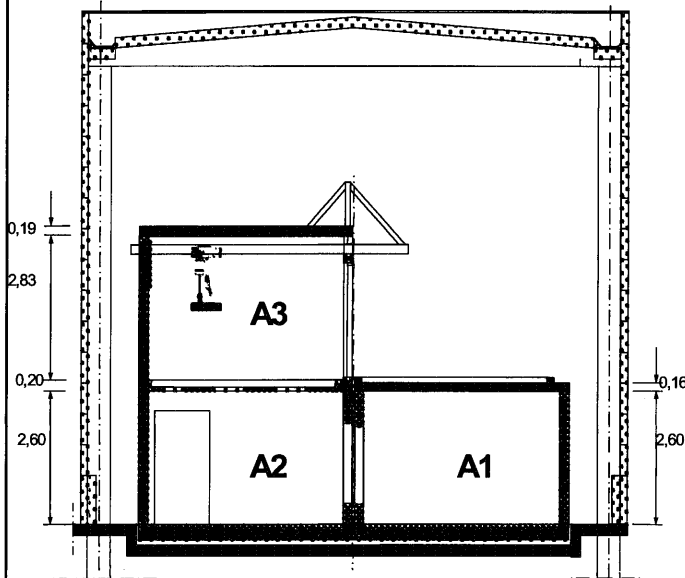

**R****SOUND REDUCTION INDEX - GELUIDVERZWAKKINGSINDEX
INDICE D'AFFAIBLISSEMENT ACOUSTIQUE - SCHALLDAMMINDEX**

EN ISO 140-3:1995 Acoustics-Measurement of sound insulation in buildings and of building elements - Part 3: Laboratory measurements of airborne sound insulation of building elements

EN ISO 717-1:1996 Acoustics - Rating of sound insulation in buildings and of building elements - Part 1: Airborne sound insulation

Date / Datum: 23/04/2007

Source room / Zenderuimte / Salle d'émission / Senderaum:

A1 (V = 50.5 m³)

Receiving room / Ontvangstruimte / Salle de réception / Empfangsraum:

A2 (V = 49.2 m³) (% H2O = 45 %) (T = 23 °C)

N° test sample / N° testelement / N° de l'élément de l'essai / Nr. Testelementes:

2007-13-007/1

Area S of test element / Opp. S testelement / Surf. S de l'élément d'essai / Fläche S des Testelementes:

1.82 m²

f (Hz)	R (dB)	
	1/3oct	oct
50		
63		
80		
100	27.3	
125	28.8	28.4
160	29.5	
200	32.8	
250	31.9	32.5
315	33.0	
400	33.0	
500	34.8	34.4
630	36.0	
800	37.1	
1000	39.8	39.5
1250	44.7	
1600	48.2	
2000	51.2	50.5
2500	54.0	
3150	57.0	
4000	60.1	59.2
5000	62.1	

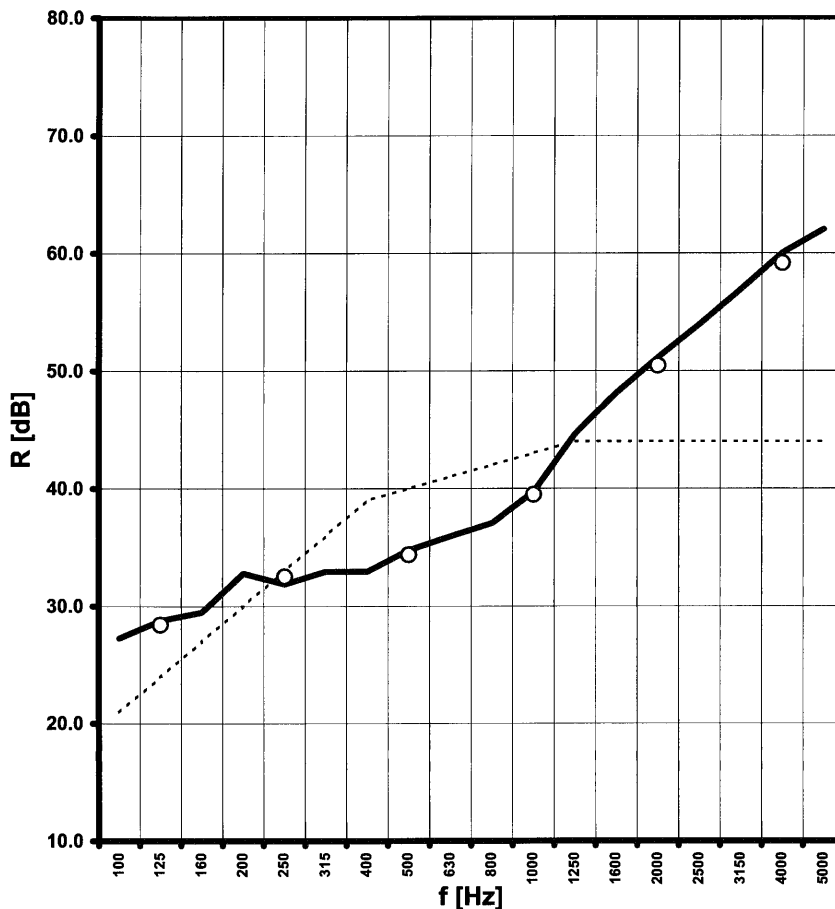
 $R_w (C; C_{tr}) =$
40 (-1; -3) dB
C₅₀₋₃₁₅₀ = -C_{tr,50-3150} = -C₅₀₋₅₀₀₀ = -C_{tr,50-5000} = -C₁₀₀₋₅₀₀₀ = -C_{tr,100-5000} = -**REQUESTED BY / AANVRAGER / DEMANDEUR / ANTRAGSTELLER:**

GLAVERBEL s.a.

Parc Industriel, zone C - B-7180 SENEFFE - Belgium

TEST ELEMENT / PROEFELEMENT / ELEMENT D'ESSAI / PRÜFMUSTER:

(Short description by the manufacturer, details: see page 4 *** Beknopte beschrijving door het bedrijf, details: zie pag. 4 *** Description sommaire par l'entreprise, détails: voir page 4 *** Kurze Beschreibung durch den Hersteller, Details auf Seite 4.)

NL: Geen nederlandse beschrijving beschikbaar**FR:** Pas de description en Français disponible**GB:** Glazing Pyrobel 21 EG - (G3mm-IL1.6mm-G3mm-IL1.6mm-G3mm-IL1.6mm-G3mm-IL1.6mm-G3mm-P0.76mm-G6mm)**D:** Keine Deutsche Beschreibung verfügbar



BIJLAGE 1: OUDE EENGETALSAANDUIDINGEN - ANNEXE 1: ANCIENNES UNIVALEURS - ANNEX 1: OLD SINGLE VALUE RATINGS

1. BELGIUM: NBN S01-400:1977 - Criteria van de akoestische isolatie - Critères de l'isolation acoustique

categorie binnenwanden - catégorie parois intérieures - category interior walls:

cat IV a

categorie gevels - catégorie façades - category façades:

cat V b

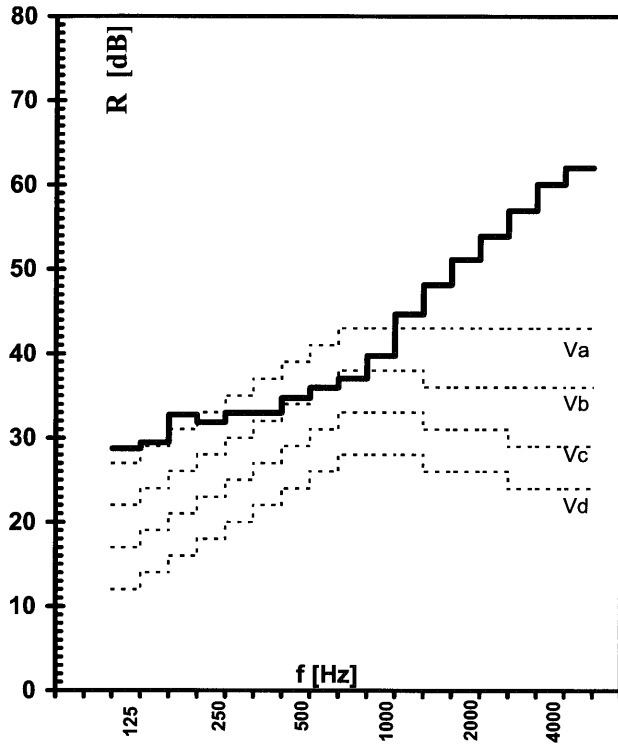

FACADES - GEVELS - FACADES

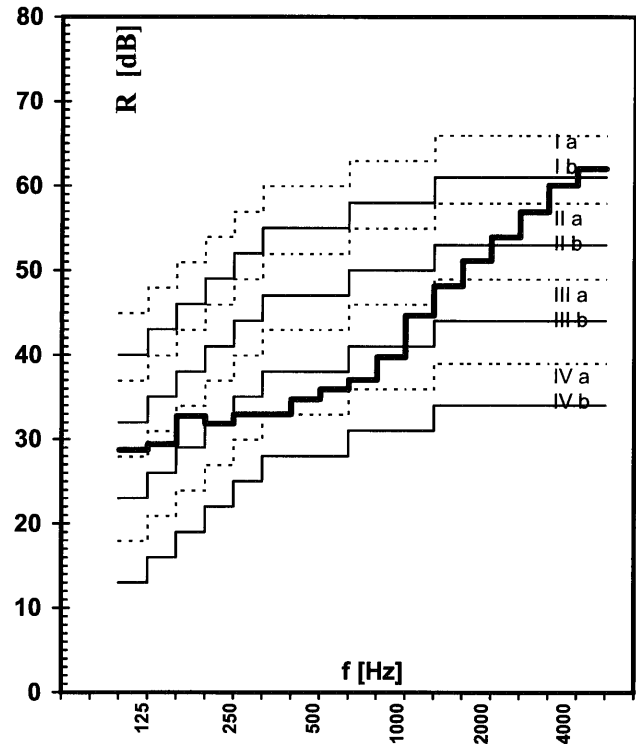

INTERIOR WALLS - BINNENWANDEN - CLOISONS

f	100	125	160	200	250	315	400	500	630	800	1000	1250	1600	2000	2500	3150	4000	5000	[Hz]
R	27.3	28.8	29.5	32.8	31.9	33.0	33.0	34.8	36.0	37.1	39.8	44.7	48.2	51.2	54.0	57.0	60.1	62.1	[dB]

2. NETHERLANDS: NEN 5079: mei 1989 Geluidwering in woongebouwen. Het weergeven in één getal van de geluidisolatie van bouwelementen, gemeten in het laboratorium.

A-gewogen geluidisolatie

buitengeluid:

$R_A = 36.2 \text{ dB(A)}$

wegverkeer:

$R_{A,v} = 36.2 \text{ dB(A)}$

railverkeer:

$R_{A,r} = 39.7 \text{ dB(A)}$

luchtverkeer:

$R_{A,l} = 37.7 \text{ dB(A)}$

Laboratoriumisolatie-index voor luchtgeluid

$I_{lu, lab} = -13 \text{ dB}$

3. FRANCE: NF S 31-051 (Décembre 1985) - Acoustique - Mesure du pouvoir d'isolation acoustique des éléments de construction et de l'isolement des immeubles. Mesure en laboratoire du pouvoir d'isolation acoustique au

Indice d'affaiblissement R exprimé en dB(A) pour un bruit rose à l'émission:

$R_{rose} = 40.3 \text{ dB(A)}$

Indice d'affaiblissement R exprimé en dB(A) pour un bruit routier à l'émission:

$R_{route} = 36.5 \text{ dB(A)}$

4. DEUTSCHLAND, GREAT-BRITAIN

The old national single ratings are the same as the R_w -EN ISO-value in this report

**ANNEX 2: MEASUREMENT METHOD AND SINGLE VALUE RATINGS****1. MEASUREMENT METHOD TO DETERMINE R**

A detailed description of the measurement method to determine the spectrum of the sound reduction indices R, can be found in the EN ISO 140-3:1995 standard (see references on the title page). In a limited and thus incomplete way, the test method can be described as follows: The measurements happen in a special laboratory construction composed of a source and a receiving room. In the source room a steady pink noise is emitted. It is generated by sound sources so as to obtain an as good as possible diffuse sound field. The average sound pressure level spectrum is measured per 1/3d octave bands in the source and receiving room using a continuous rotating microphone. Measurements are carried out during at least a full rotation in 3 different planes. In that way, an integration in time and space of the sound pressure level is obtained, resulting in an average sound pressure level spectrum for the source and receiving room.

The reverberation time T is equally measured in the receiving room which allows to calculate the correction term in the formula for the sound reduction index R (via the equation of Sabine: $A=0.16V/T$, V = volume of the receiving room). The sound reduction index R is calculated with the formula:

$$R = L_{pm1} - L_{pm2} + 10 \log(S/A) \text{ [dB]}$$

L_{pm1} = the average (space / time) sound pressure level per 1/3d octave bands in the source room [dB] (ref. 20 micro Pa)

L_{pm2} = the average (space / time) sound pressure level per 1/3d octave bands in the receiving room [dB] (ref. 20 micro Pa)

S = the surface of the test element in m²;

A = the equivalent absorption-surface of the receiving room in m² (obtained by Sabine's equation)

Temperature (°C) and relative humidity (%) of the air are measured in the receiving room and mentioned between brackets in the graphics on page 3 and 4 (next to the volume of the receiving room).

More information about the measurement equipment, the setup and the testcells can be found in annex 3

2. R_w ($C;C_{tr}$): RATING OF THE SOUND INSULATION

$R_w + C_{tr}$: Characterizes the sound insulation against dominantly low frequency noise of a test element in a single value.

$R_w + C$: Characterizes the sound insulation against NON-dominantly low frequency noise of an element in a single value.

Calculations are carried out as to EN ISO 717-1:1996 (see references title page) and cannot be explained in a few lines. On page 4, additional sound ratings are given as to old national standards in different countries (B, NL, FR). Calculation modules and supplementary information about the rating of sound insulation (and about standards related to building acoustics in general) are given on the website of the laboratory of acoustics at the following address:

<http://www.normes.be>



ANNEX 3: DETAILED DESCRIPTION OF THE BUILDING ELEMENT

This description is given by the producer of the test element and is not guaranteed by the laboratory. The equivalence between the tested product in this report and the commercialised product is the sole responsibility of the producer.

Glazing Pyrobel 21 EG - (G3mm-IL1.6mm-G3mm-IL1.6mm-G3mm-IL1.6mm-G3mm-IL1.6mm-G3mm-P0.76mm-G6mm)

	thickness [mm]	ρ [kg/m ³]	m'' [kg/m ²]	description
1	3 mm	2500 kg/m ³	7.5 kg/m ²	Glass
2	1.6 mm			/ Intumescent Layer
3	3 mm	2500 kg/m ³	7.5 kg/m ²	Glass
4	1.6 mm			/ Intumescent Layer
5	3 mm	2500 kg/m ³	7.5 kg/m ²	Glass
6	1.6 mm			/ Intumescent Layer
7	3 mm	2500 kg/m ³	7.5 kg/m ²	Glass
8	1.6 mm			/ Intumescent Layer
9	3 mm	2500 kg/m ³	7.5 kg/m ²	Glass
10	0.76 mm	1015 kg/m ³	0.7714 kg/m ²	PVB
11	3 mm	2500 kg/m ³	7.5 kg/m ²	Glass
12				

CALCULATED TOTAL THICKNESS = 25.2 mm
MEASURED TOTAL THICKNESS = 0 mm

CALCULATED TOTAL OF THE SURFACE MASS = 45.8 kg/m²
MEASURED TOTAL OF THE SURFACE MASS = 0 kg/m²



Handwritten signature and date: 2010